

#IntoYourFuture



TELLUR

#FollowTellur

Car phone holder CMH10





For your daily car rides or when going on a long trip - the new CMH10 car phone holder will keep your device in place and at your eyesight.



Simple Design



No abnormal sound



One-hand play



Safe clamping



New structure

Need to recharge your phone while driving?
No worries!



Adjusted leftwards
and rightwards



Adjusted up and down

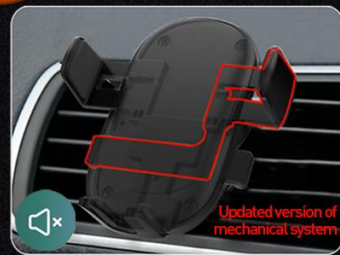
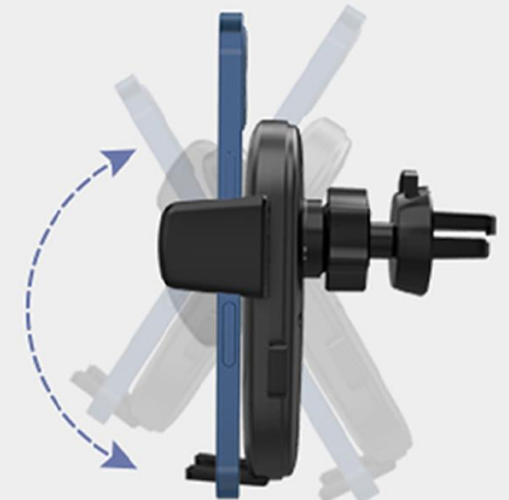

Easy access to the charging port of the smartphone for any cable

1 Press the modules of both sides



2 Put the phone on the phone holder









3 Clamping automatically after your phone touch the base of the holder



Safety



-  Speed bump  Up and down
-  Sudden braking  Pitching and rolling
-  Off-road  Shaking



Flexible silicone
Skid resistance



360°



Suitable for 4.7-6.7 inch

Universal for iPhone, android and phone with case



4.7inch

6.7inch

Suitable for most of air vents



Technical specs



Material:	ABS, Silicone
Compatibility:	4.7" - 6.7"
Characteristics:	Easy one-hand Operation, 360° rotation, Safe clamping, Suitable for most air vents, Thickened silicone pads
Installation:	Air vent
Dimensions:	106x106x60mm
Weight:	69g
Color:	Black
Package includes:	1 x CMH10 car phone holder, 1 x Manual
Package dimensions:	112*60*105mm
Package weight:	105g
Product code:	TLL171201
EAN:	5949120003698

THANK YOU!

For more products, please
visit : tellur.com.

